

# EMC TEST REPORT

Applicant : Chengdu Greenfaith New Energy Technology Co., Ltd.  
Address : Room 4008, Building 3, 88 Jitai 5th Road, High-Tech Zone, Pilot Free Trade Zone, Chengdu, Sichuan, P.R.China  
Manufacturer : Sinocat Environmental Technology Co., Ltd.  
Address : No.88, Gunan Street, High-Tech Zone, Chengdu City, Sichuan, China  
EUT : LiFePO4 Battery(Li-ion)  
Model No : LFW51200  
Brand Name: : N/A  
Report Number : XK2312013090E-A1  
Test Date : December 26-January 2, 2024  
Date of Issue : January 12, 2024  
Test Result: : The equipment under test was found to be compliance with the requirements of the standards applied.  
Test Procedure Used:  
EN IEC 61000-6-3:2021  
EN IEC 61000-6-1:2019  
: EN 61000-3-3:2013+A2:2021+AC:2022  
EN IEC 61000-3-2:2019+A1:2021

**Prepared By:****Shenzhen SiCT Technology Co., Ltd.**

202, Building 3, No.111 Huanguan Middle Road, Songyuanxia Community, Guanhu Street,  
Longhua District, Shenzhen, Guangdong, China

Compiled by:



Reviewed by:



Approved by:



*This test report is based on a single evaluation of one sample of above mentioned products. It is not permitted to be duplicated in extracts without written approval of Shenzhen SiCT Technology Co., Ltd.*

**TABLE OF CONTENTS**

|   |           |
|---|-----------|
| <b>1 - GENERAL INFORMATION .....</b>  | <b>4</b>  |
| 1.1 PRODUCT DESCRIPTION FOR EQUIPMENT UNDER TEST (EUT) .....  | 4         |
| 1.2 TEST STANDARDS .....  | 5         |
| 1.3 TEST SUMMARY .....  | 5         |
| 1.4 TEST METHODOLOGY .....  | 6         |
| 1.5 TEST FACILITY .....   | 6         |
| 1.6 TEST EQUIPMENT LIST AND DETAILS .....   | 6         |
| 1.7 DESCRIPTION OF TEST MODES .....   | 8         |
| <b>2 - SYSTEM TEST CONFIGURATION .....</b>  | <b>9</b>  |
| 2.1 JUSTIFICATION .....   | 9         |
| 2.2 EUT EXERCISE SOFTWARE .....   | 9         |
| 2.3 SPECIAL ACCESSORIES .....   | 9         |
| 2.4 TEST SETUP DIAGRAM .....  | 9         |
| 2.5 GENERAL DESCRIPTION OF TEST AUXILIARY .....   | 9         |
| <b>3 - DISTURBANCE VOLTAGE AT THE MAINS TERMINALS .....</b>   | <b>10</b> |
| 3.1 MEASUREMENT UNCERTAINTY .....   | 10        |
| 3.2 LIMIT OF DISTURBANCE VOLTAGE AT THE MAINS TERMINALS (CLASS B) .....                                       | 10        |
| 3.3 EUT SETUP .....   | 10        |
| 3.4 INSTRUMENT SETUP .....  | 11        |
| 3.5 TEST PROCEDURE .....  | 11        |
| 3.6 SUMMARY OF TEST RESULTS .....   | 11        |
| 3.7 RADIATED EMISSIONS TEST DETAIL AND TEST RESULT .....  | 11        |
| <b>4 - RADIATED DISTURBANCES .....</b>  | <b>12</b> |
| 4.1 MEASUREMENT UNCERTAINTY .....   | 12        |
| 4.2 LIMIT OF RADIATED DISTURBANCES (CLASS B) .....  | 12        |
| 4.3 EUT SETUP .....   | 12        |
| 4.4 TEST RECEIVER SETUP .....   | 13        |
| 4.5 TEST PROCEDURE .....  | 13        |
| 4.6 CORRECTED AMPLITUDE & MARGIN CALCULATION .....  | 13        |
| 4.7 RADIATED EMISSIONS TEST DETAIL AND TEST RESULT .....  | 14        |
| <b>5- HARMONIC CURRENT TEST .....</b>   | <b>16</b> |
| 5.1 APPLICATION OF HARMONIC CURRENT EMISSION .....  | 16        |
| 5.2 BLOCK DIAGRAM OF TEST SETUP: .....  | 16        |
| 5.3 TEST PROCEDURE: .....   | 16        |
| 5.4 TEST RESULT .....   | 17        |
| <b>6 - VOLTAGE FLUCTUATIONS AND FLICKER TEST .....</b>  | <b>18</b> |
| 6.1 APPLICATION AND LIMIT OF VOLTAGE FLUCTUATIONS AND FLICKER TEST .....                                      | 18        |
| 6.2 BLOCK DIAGRAM OF TEST SETUP: .....  | 18        |
| 6.3 TEST PROCEDURE: .....   | 18        |
| 6.4 TEST RESULT .....   | 19        |
| <b>7- IMMUNITY TEST DESCRIPTION .....</b>   | <b>20</b> |
| 7.1 GENERAL DESCRIPTION .....   | 20        |
| 7.2 THE PHENOMENA ALLOWED DURING AND AFTER TEST IN EACH CRITERION ARE CLEARLY STATED IN THE FOLLOWING TABLE21 |           |
| 7.3 DEVIATIONS FROM THE STANDARD .....  | 21        |
| <b>8- IMMUNITY TEST RESULTS .....</b>   | <b>22</b> |
| 8.1 ELECTROSTATIC DISCHARGE IMMUNITY TEST .....   | 22        |
| 8.1.1 TEST SPECIFICATION .....  | 22        |
| 8.1.2 TEST SETUP .....  | 22        |
| 8.1.3 TEST PROCEDURE .....  | 23        |
| 8.1.4 PERFORMANCE CRITERION REQUIRED & TEST RESULT .....  | 24        |
| 8.2 RADIATED SUSCEPTIBILITY TEST .....  | 25        |
| 8.2.1 TEST SPECIFICATION .....  | 25        |
| 8.2.2 TEST SETUP .....  | 25        |
| 8.2.3 TEST PROCEDURE .....  | 25        |

|  |           |
|--|-----------|
| 8.2.4 PERFORMANCE CRITERION REQUIRED & TEST RESULT .....   | 26        |
| 8.3 ELECTRICAL FAST TRANSIENT/BURST IMMUNITY TEST .....    | 27        |
| 8.3.1 TEST SPECIFICATION .....                             | 27        |
| 8.3.2 TEST SETUP .....                                     | 27        |
| 8.3.3 TEST PROCEDURE .....                                 | 28        |
| 8.3.4 PERFORMANCE CRITERION REQUIRED & TEST RESULT .....   | 28        |
| 8.4 SURGE IMMUNITY TEST .....                              | 29        |
| 8.4.1 TEST SPECIFICATION .....                             | 29        |
| 8.4.2 TEST SETUP .....                                     | 29        |
| 8.4.3 TEST PROCEDURE .....                                 | 30        |
| 8.4.4 PERFORMANCE CRITERION REQUIRED & TEST RESULT .....   | 30        |
| 8.5 CONDUCTED SUSCEPTIBILITY TEST .....                    | 31        |
| 8.5.1 TEST SPECIFICATION .....                             | 31        |
| 8.5.2 TEST SETUP .....                                     | 31        |
| 8.5.3 TEST PROCEDURE .....                                 | 31        |
| 8.5.4 PERFORMANCE CRITERION REQUIRED & TEST RESULT .....   | 32        |
| 8.6 VOLTAGE DIPS, SHORT INTERRUPTIONS IMMUNITY TESTS ..... | 33        |
| 8.6.1 TEST SPECIFICATION .....                             | 33        |
| 8.6.2 TEST SETUP .....                                     | 33        |
| 8.6.3 TEST PROCEDURE .....                                 | 33        |
| 8.6.4 PERFORMANCE CRITERION REQUIRED & TEST RESULT .....   | 34        |
| <b>APPENDIX A - EUT PHOTOGRAPHS .....</b>                  | <b>35</b> |

## 1 - GENERAL INFORMATION

### 1.1 Product Description for Equipment Under Test (EUT)

#### Client Information

|                          |  |
|--------------------------|--|
| Applicant:               | Chengdu Greenfaith New Energy Technology Co., Ltd.   |
| Address of applicant:    | Room 4008, Building 3, 88 Jitai 5th Road, High-Tech Zone, Pilot Free Trade Zone, Chengdu, Sichuan, P.R.China |
| Manufacturer:            | Sinocat Environmental Technology Co., Ltd.   |
| Address of manufacturer: | No.88, Gunan Street, High-Tech Zone, Chengdu City, Sichuan, China  |

#### General Description of E.U.T

|                  |                              |
|------------------|------------------------------|
| EUT Name:        | LiFePO4 Battery(Li-ion)      |
| Trade mark:      | N/A                          |
| Test Model:      | LFW51200                     |
| Model(s):        | LFW51100, LFR51100, LFR51200 |
| Operating Mode.: | Mode1:Power on               |
| Power Rating:    | Input:DC 51.2V               |

Remark: \* *The test data gathered are from the production sample provided by the manufacturer.*  
\* *Supplementary models have the same circuit, but with different appearance.*

## 1.2 Test Standards

The following Declaration of Conformity report of EUT is prepared in accordance with

EN IEC 61000-6-3:2021

EN IEC 61000-6-1:2019

EN IEC 61000-3-2:2019+A1:2021

EN 61000-3-3:2013+A2:2021+AC:2022

The objective of the manufacturer is to demonstrate compliance with the described standards above.

## 1.3 Test Summary

For the EUT described above. The standards used were EN 61000-6-3 Class B for Emissions & EN 61000-6-1 for Immunity.

Table 1 : Tests Carried Out Under EN IEC 61000-6-3:2021

| Standard              | Test Items   | Status |
|-----------------------|--|--------|
| EN IEC 61000-6-3:2021 | Disturbance Voltage at The Mains Terminals (150KHz To 30MHz) | ×      |
|                       | Radiated Disturbances (30MHz To 1000MHz)                     | √      |

√ Indicates that the test is applicable

× Indicates that the test is not applicable

Table 2 : Tests Carried Out Under EN IEC 61000-3-2:2019+A1:2021/ EN 61000-3-3:2013+A2:2021

| Standard                          | Test Items                            | Status |
|-----------------------------------|---------------------------------------|--------|
| EN IEC 61000-3-2:2019+A1:2021     | Harmonic Current Test                 | ×      |
| EN 61000-3-3:2013+A2:2021+AC:2022 | Voltage Fluctuations and Flicker Test | ×      |

√ Indicates that the test is applicable

× Indicates that the test is not applicable

Table 3 : Tests Carried Out Under EN IEC 61000-6-1:2019

| Standard                       | Test Items  | Status |
|--------------------------------|---|--------|
| EN 61000-4-2:2009              | Electrostatic discharge Immunity                  | √      |
| EN IEC 61000-4-3:2020          | Radiated Susceptibility (80MHz to 1GHz)           | √      |
| EN 61000-4-4:2012              | Electrical Fast Transient/Burst Immunity          | ×      |
| EN 61000-4-5:2014+A1:2017      | Surge Immunity                                    | ×      |
| EN 61000-4-6:2014+AC:2015      | Conducted Susceptibility (150kHz to 80MHz)        | ×      |
| EN 61000-4-8: 2010             | Power Frequency Magnetic Field Immunity (50/60Hz) | ×      |
| EN IEC 61000-4-11:2020/AC:2022 | Voltage Dips, Short Interruptions Immunity        | ×      |

√ Indicates that the test is applicable

× Indicates that the test is not applicable

## 1.4 Test Methodology

All measurements contained in this report were conducted with CISPR 16-1-1: 2019, Radio disturbance and immunity measuring apparatus – Measuring apparatus, and CISPR 16-2-3: 2010, Method of measurement of disturbances and immunity.

## 1.5 Test Facility

Shenzhen SiCT Technology Co., Ltd.

202, Building 3, No.111 Huanguan Middle Road, Songyuanxia Community, Guanhu Street, Longhua District, Shenzhen, Guangdong, China

## 1.6 Test Equipment List and Details

### 1.6.1 CONDUCTED EMISSION

| Item | Kind of Equipment     | Manufacturer    | Type No.   | Serial No. | Last calibration | Calibrated until | Calibration period |
|------|-----------------------|-----------------|------------|------------|------------------|------------------|--------------------|
| 1    | LISN                  | R&S             | ENV216     | 101334     | Mar. 20,2023     | Mar. 19,2024     | 1 year             |
| 2    | LISN                  | SCHWARZBEC<br>K | NNLK 8129  | 8129267    | Mar. 20,2023     | Mar. 19,2024     | 1 year             |
| 3    | Pulse Limiter         | SCHWARZBEC<br>K | VTSD 9561F | 9716       | Mar. 20,2023     | Mar. 19,2024     | 1 year             |
| 4    | 50Ω SWITCH            | ANRITSU<br>CORP | MP59B      | 6200983704 | Mar. 20,2023     | Mar. 19,2024     | 1 year             |
| 5    | TEST CABLE            | N/A             | C01        | N/A        | Mar. 20,2023     | Mar. 19,2024     | 1 year             |
| 6    | TEST CABLE            | N/A             | C02        | N/A        | Mar. 20,2023     | Mar. 19,2024     | 1 year             |
| 7    | TEST CABLE            | N/A             | C03        | N/A        | Mar. 20,2023     | Mar. 19,2024     | 1 year             |
| 8    | EMI Test Receiver     | R&S             | ESCI       | 101318     | Mar. 20,2023     | Mar. 19,2024     | 1 year             |
| 9    | Passive Voltage Probe | ESH2-Z3         | R&S        | 100173     | Mar. 20,2023     | Mar. 19,2024     | 1 year             |
| 10   | Triple-Loop Antenna   | EVERFINE        | LIA-2      | 11020016   | Mar. 20,2023     | Mar. 19,2024     | 1 year             |
| 11   | Absorbing Clamp       | R&S             | MDS-21     | 100423     | Mar. 20,2023     | Mar. 19,2024     | 1 year             |

### 1.6.2 RADIATED TEST SITE

| Item | Kind of Equipment | Manufacturer  | Type No. | Serial No. | Last calibration | Calibrated until | Calibration period |
|------|-------------------|---------------|----------|------------|------------------|------------------|--------------------|
| 1    | Bilog Antenna     | TESEQ         | CBL6111D | 31437      | Mar. 20,2023     | Mar. 19,2024     | 1 year             |
| 2    | Test Cable        | N/A           | R-01     | N/A        | Mar. 20,2023     | Mar. 19,2024     | 1 year             |
| 3    | Test Cable        | N/A           | R-02     | N/A        | Mar. 20,2023     | Mar. 19,2024     | 1 year             |
| 4    | EMI Test Receiver | Rohde&Schwarz | ESVD     | 847312/008 | Mar. 20,2023     | Mar. 19,2024     | 1 year             |
| 5    | Antenna Mast      | EM            | SC100_1  | N/A        | N/A              | N/A              | N/A                |
| 6    | Turn Table        | EM            | SC100    | 060533     | N/A              | N/A              | N/A                |

|    |                   |              |             |            |              |              |        |
|----|-------------------|--------------|-------------|------------|--------------|--------------|--------|
| 7  | 50Ω Switch        | Anritsu Corp | MP59B       | 6200983705 | Mar. 20,2023 | Mar. 19,2024 | 1 year |
| 8  | SPECTRUM ANALYZER | Aglient      | E4407B      | 160400005  | Mar. 20,2023 | Mar. 19,2024 | 1 year |
| 9  | HORN ANTENNA      | EM           | EM-AH-10180 | 2011071402 | Mar. 20,2023 | Mar. 19,2024 | 1 year |
| 10 | AMPLIFIER         | EM           | EM-30180    | 060536     | Mar. 20,2023 | Mar. 19,2024 | 1 year |

1.6.3 ESD

| Item | Kind of Equipment  | Manufacturer | Type No. | Serial No. | Last calibration | Calibrated until | Calibration period |
|------|--------------------|--------------|----------|------------|------------------|------------------|--------------------|
| 1    | ESD TEST GENERATOR | SCHAFFNER    | NSG438   | 858        | Mar. 20,2023     | Mar. 19,2024     | 1 year             |

1.6.4 RS

| Item | Kind of Equipment      | Manufacturer | Type No.   | Serial No. | Last calibration | Calibrated until | Calibration period |
|------|------------------------|--------------|------------|------------|------------------|------------------|--------------------|
| 1    | Signal Generator       | R&S          | SMT 06     | 832080/007 | Mar. 20,2023     | Mar. 19,2024     | 1 year             |
| 2    | Log-Bicon Antenna      | Schwarzbeck  | VULB9161   | 4022       | Mar. 20,2023     | Mar. 19,2024     | 1 year             |
| 3    | Power Amplifier        | AR           | 150W1000M1 | 320946     | Mar. 20,2023     | Mar. 19,2024     | 1 year             |
| 4    | Microwave Horn Antenna | AR           | AT4002A    | 321467     | Mar. 20,2023     | Mar. 19,2024     | 1 year             |
| 5    | Power Amplifier        | AR           | 25S1G4A    | 308598     | Mar. 20,2023     | Mar. 19,2024     | 1 year             |

## 1.7 DESCRIPTION OF TEST MODES

To investigate the maximum EMI emission characteristics generates from EUT, the test system was pre-scanning tested base on the consideration of following EUT operation mode or test configuration mode which possible have effect on EMI emission level. Each of these EUT operation mode(s) or test configuration mode(s) mentioned above was evaluated respectively.

| Pretest Mode | Description |
|--------------|-------------|
| Mode 1       | Power on    |
| Mode 2       | /           |

| For Conducted Test |             |
|--------------------|-------------|
| Final Test Mode    | Description |
| Mode 1             | Power on    |
| Mode 2             | /           |

| For Radiated Test |             |
|-------------------|-------------|
| Final Test Mode   | Description |
| Mode 1            | Power on    |
| Mode 2            | /           |

| For EMS Test    |             |
|-----------------|-------------|
| Final Test Mode | Description |
| Mode 1          | Power on    |
| Mode 2          | /           |



## 2 - SYSTEM TEST CONFIGURATION

### 2.1 Justification

The system was configured for testing in a typical fashion (as normally used by a typical user).

### 2.2 EUT Exercise Software

The EUT exercising program used during radiated and conducted testing was designed to exercise the various system components in a manner similar to a typical use. The software offered by manufacture, can let the EUT being normal operation.

### 2.3 Special Accessories

Emission: The equipment under test (EUT) was configured to measure its highest possible radiation level. The test modes were adapted accordingly in reference to the Operating Instructions.

Immunity: The equipment under test (EUT) was configured to the representative operating mode and conditions.

### 2.4 Test Setup Diagram

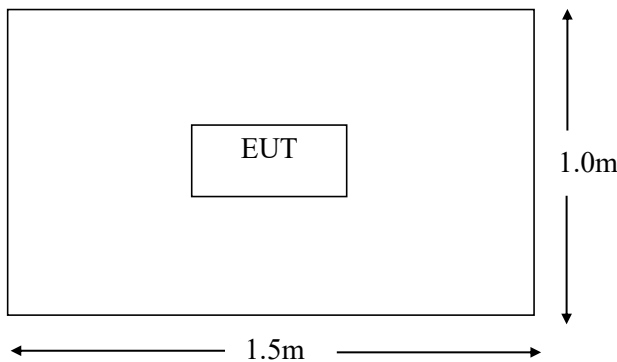

### 2.5 General Description of Test Auxiliary

| EUT Cable List and Details |            |                     |                        |
|----------------------------|------------|---------------------|------------------------|
| Cable Description          | Length (m) | Shielded/Unshielded | With / Without Ferrite |
| /                          |            | /                   |                        |
| /                          | /          | /                   | /                      |
| /                          | /          | /                   | /                      |

### 3 - DISTURBANCE VOLTAGE AT THE MAINS TERMINALS

#### 3.1 Measurement Uncertainty

All measurements involve certain levels of uncertainties, especially in field of EMC. The factors contributing to uncertainties are spectrum analyzer, cable loss, and LISN.

The Treatment of Uncertainty in EMC Measurements, the best estimate of the uncertainty of any conducted emissions measurement is 2.7 dB.

#### 3.2 Limit of Disturbance Voltage At The Mains Terminals (Class B)

| Frequency Range (MHz) | Limits ( dBuV) |         |
|-----------------------|----------------|---------|
|                       | Quasi-Peak     | Average |
| 0.150~0.500           | 66~56          | 56~46   |
| 0.500~5.000           | 56             | 46      |
| 5.000~30.00           | 60             | 50      |

Note: (1) The tighter limit shall apply at the edge between two frequency bands.

#### 3.3 EUT Setup

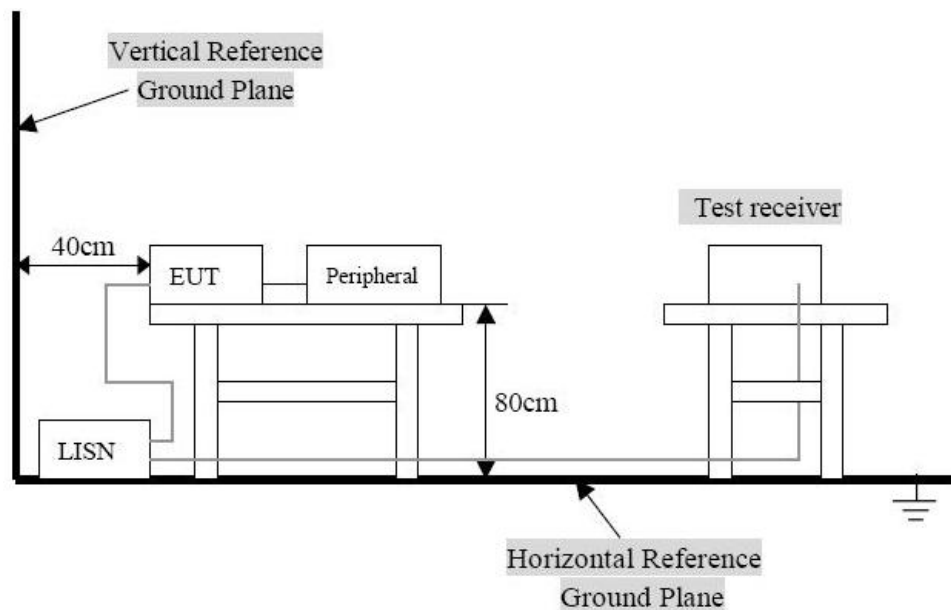

### 3.4 Instrument Setup

The test receiver was set with the following configurations:

Test Receiver Setting:

Frequency Range.....150 KHz to 30 MHz  
Detector.....Peak & Quasi-Peak & Average  
Sweep Speed.....Auto  
IF Band Width.....9 KHz

### 3.5 Test Procedure

During the conducted emission test, the EUT power cord was connected to the auxiliary outlet of the first Artificial Mains.

Maximizing procedure was performed on the six (6) highest emissions to ensure EUT compliance using all installation combination.

All data was recorded in the peak detection mode. Quasi-peak and Average readings were only performed when an emission was found to be marginal (within -10 dB  $\mu$  V of specification limits). Quasi-peak readings are distinguished with a "QP". Average readings are distinguished with a "AV".

### 3.6 Summary of Test Results

According to the data in section 3.6, the EUT complied with the EN 61000-6-3 Conducted margin, with the *worst* margin reading of:

### 3.7 Radiated Emissions Test Detail And Test Result

#### Conducted Emission Test

Passed                       Not Applicable

Note: The EUT is DC supply, so this test item is not applicable.

## 4 - RADIATED DISTURBANCES

### 4.1 Measurement Uncertainty

All measurements involve certain levels of uncertainties, especially in field of EMC. The factors contributing to uncertainties are spectrum analyzer, cable loss, antenna factor calibration, antenna directivity, antenna factor variation with height, antenna phase center variation, antenna factor frequency interpolation, measurement distance variation, site imperfections, mismatch (average), and system repeatability.

The Treatment of Uncertainty in EMC Measurements, the best estimate of the uncertainty of a radiation emissions measurement is 4.5 dB.

### 4.2 Limit of Radiated Disturbances (Class B)

| Frequency (MHz) | Distance (Meters) | Field Strengths Limits (dB $\mu$ V/m) |
|-----------------|-------------------|---------------------------------------|
| 30 ~ 230        | 3                 | 40                                    |
| 230 ~ 1000      | 3                 | 47                                    |

Note: (1) The tighter limit shall apply at the edge between two frequency bands.  
 (2) Distance refers to the distance in meters between the test instrument antenna and the closest point of any part of the E.U.T.

### 4.3 EUT Setup

The radiated emission tests were performed in the open area 3-meter test site, using the setup accordance with the CISPR 16-1-1:2019, CISPR16-2-3:2016+A1:2019. The specification used was EN 61000-6-3 Class B limits.

The EUT was placed on the center of the test table.

Maximum emission emitted from EUT was determined by manipulating the EUT, support equipment, interconnecting cables and varying the mode of operation and the levels in the final result of the test were recorded with the EUT running in the operating mode that maximum emission was emitted.

Block diagram of test setup (In chamber)

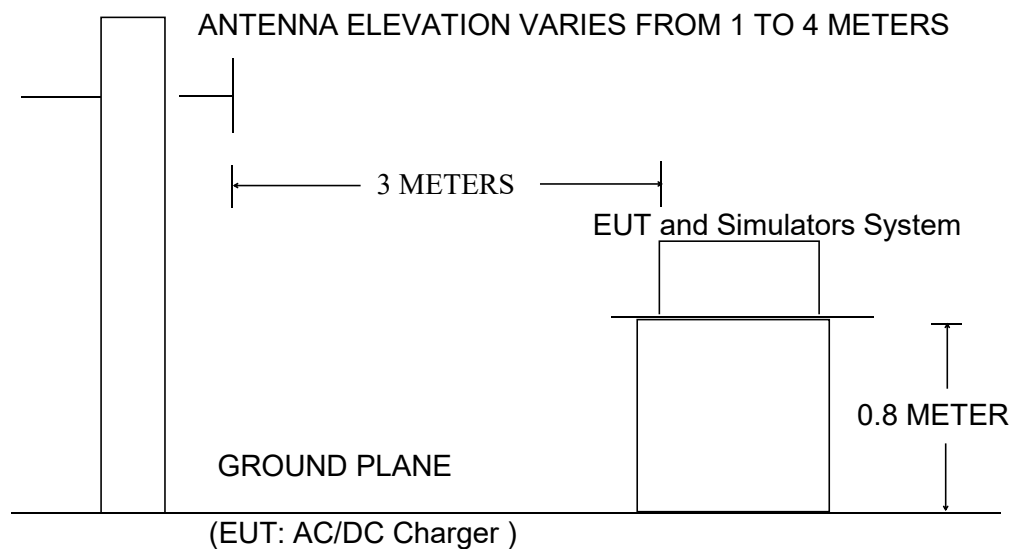

#### 4.4 Test Receiver Setup

According to EN 61000-6-3 rules, the frequency was investigated from 30 to 1000 MHz. During the radiated emission test, the test receiver was set with the following configurations:

Test Receiver Setting:

Detector.....Peak & Quasi-Peak  
IF Band Width.....120KHz  
Frequency Range.....30MHz to 1000MHz  
Turntable Rotated.....0 to 360 degrees

Antenna Position:

Height.....1m to 4m  
Polarity.....Horizontal and Vertical

#### 4.5 Test Procedure

Maximizing procedure was performed on the highest emissions to ensure that the EUT complied with all installation combinations.

All data was recorded in the peak detection mode. Quasi-peak readings performed only when an emission was found to be marginal (within -10 dB  $\mu$  V of specification limits), and are distinguished with a "QP" in the data table.

#### 4.6 Corrected Amplitude & Margin Calculation

The Corrected Amplitude is calculated by adding the Antenna Factor and Cable Factor, and subtracting the Amplifier Gain from the Amplitude reading. The basic equation is as follows:

$$\text{Corr. Ampl.} = \text{Indicated Reading} + \text{Antenna Factor} + \text{Cable Factor} - \text{Amplifier Gain}$$

The "**Margin**" column of the following data tables indicates the degree of compliance with the applicable limit. For example, a margin of 7dB  $\mu$  V means the emission is 7dB  $\mu$  V below the maximum limit for Class B. The equation for margin calculation is as follows:

$$\text{Margin} = \text{Limit} - \text{Corr. Ampl.}$$

### 4.7 Radiated Emissions Test Detail And Test Result

#### Radiated Emission Test Data of Below 1GHz

|             |                         |                    |            |
|-------------|-------------------------|--------------------|------------|
| EUT:        | LiFePO4 Battery(Li-ion) | Model Name:        | LFW51200   |
| Temperature | 24 °C                   | Relative Humidity: | 55%        |
| Pressure:   | 1025hPa                 | Test Polarity :    | Horizontal |
| Test Mode   | Mode1                   | Test Voltage:      | 51.2V      |

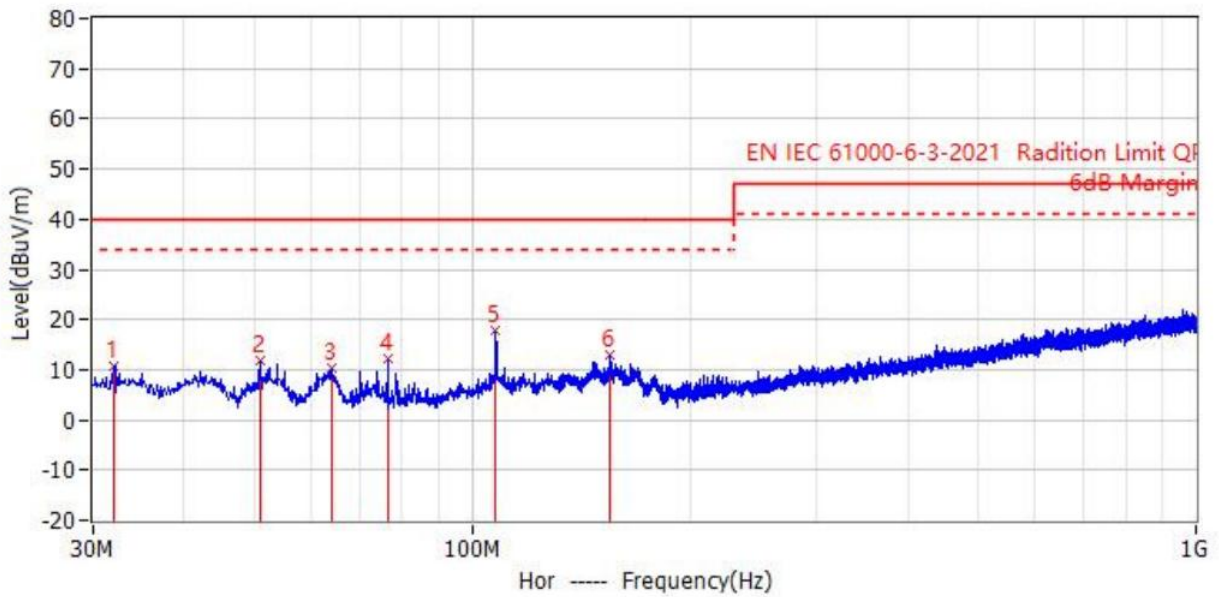

| No. | Frequency  | Limit dBuV/m | Level dBuV/m | Delta dB | Reading dBuV | Factor dB/m | Detector | Polar | Height cm | Angle deg |
|-----|------------|--------------|--------------|----------|--------------|-------------|----------|-------|-----------|-----------|
| 1*  | 32.061MHz  | 40.0         | 10.8         | -29.2    | 27.7         | -16.9       | QP       | Hor   | 100.0     | 131.0     |
| 2*  | 50.976MHz  | 40.0         | 11.7         | -28.3    | 28.6         | -16.9       | QP       | Hor   | 100.0     | 228.0     |
| 3*  | 64.193MHz  | 40.0         | 10.3         | -29.7    | 28.7         | -18.4       | QP       | Hor   | 100.0     | 290.0     |
| 4*  | 76.681MHz  | 40.0         | 12.2         | -27.8    | 32.7         | -20.5       | QP       | Hor   | 100.0     | 340.0     |
| 5*  | 107.964MHz | 40.0         | 17.8         | -22.2    | 36.8         | -19.0       | QP       | Hor   | 100.0     | 2.0       |
| 6*  | 154.766MHz | 40.0         | 12.8         | -27.2    | 28.2         | -15.4       | QP       | Hor   | 100.0     | 70.0      |

**Radiated Emission Test Data of Below 1GHz**

|             |                         |                    |          |
|-------------|-------------------------|--------------------|----------|
| EUT:        | LiFePO4 Battery(Li-ion) | Model Name:        | LFW51200 |
| Temperature | 24 °C                   | Relative Humidity: | 55%      |
| Pressure:   | 1025hPa                 | Test Polarity :    | Vertical |
| Test Mode   | Mode1                   | Test Voltage:      | 51.2V    |

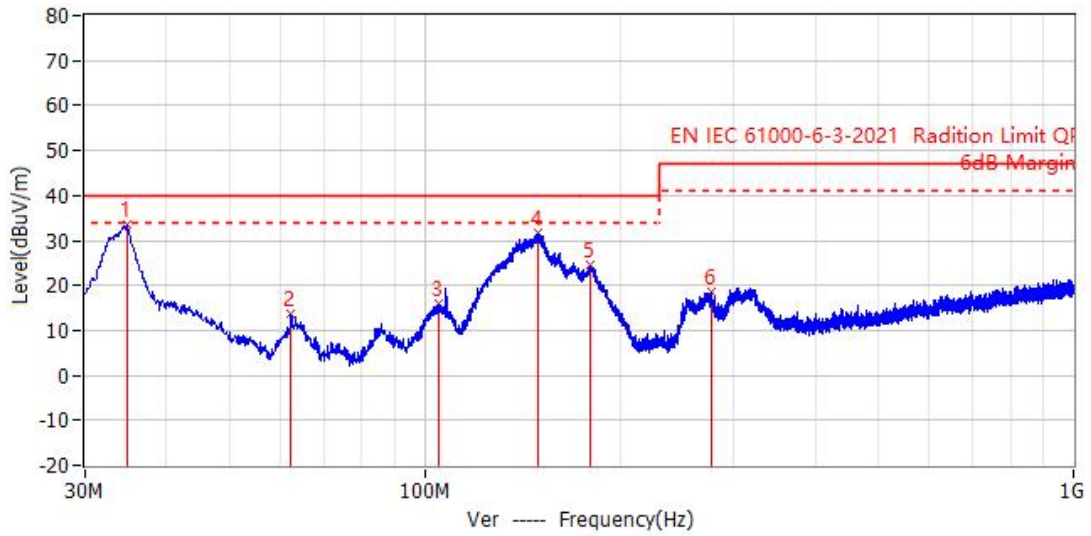

| No. | Frequency  | Limit dBuV/m | Level dBuV/m | Delta dB | Reading dBuV | Factor dB/m | Detector | Polar | Height cm | Angle deg |
|-----|------------|--------------|--------------|----------|--------------|-------------|----------|-------|-----------|-----------|
| 1*  | 34.850MHz  | 40.0         | 33.7         | -6.3     | 50.4         | -16.7       | QP       | Ver   | 100.0     | 280.0     |
| 2*  | 62.253MHz  | 40.0         | 13.7         | -26.3    | 31.7         | -18.0       | QP       | Ver   | 100.0     | 0.0       |
| 3*  | 105.418MHz | 40.0         | 15.8         | -24.2    | 35.0         | -19.2       | QP       | Ver   | 100.0     | 280.0     |
| 4*  | 149.674MHz | 40.0         | 31.7         | -8.3     | 47.3         | -15.6       | QP       | Ver   | 100.0     | 164.0     |
| 5*  | 179.986MHz | 40.0         | 24.4         | -15.6    | 42.2         | -17.8       | QP       | Ver   | 100.0     | 2.0       |
| 6*  | 276.138MHz | 47.0         | 18.6         | -28.4    | 35.3         | -16.7       | QP       | Ver   | 100.0     | 329.0     |

## 5– HARMONIC CURRENT TEST

### 5.1 Application of Harmonic Current Emission

Compliance to these standards ensures that tested equipment will not generate harmonic currents at levels that cause unacceptable degradation of the main environment. This directly contributes to meeting compatibility levels established in other EMC standards, which defines compatibility levels for low-frequency conducted disturbances in low-voltage supply systems.

### 5.2 Block Diagram of Test Setup:

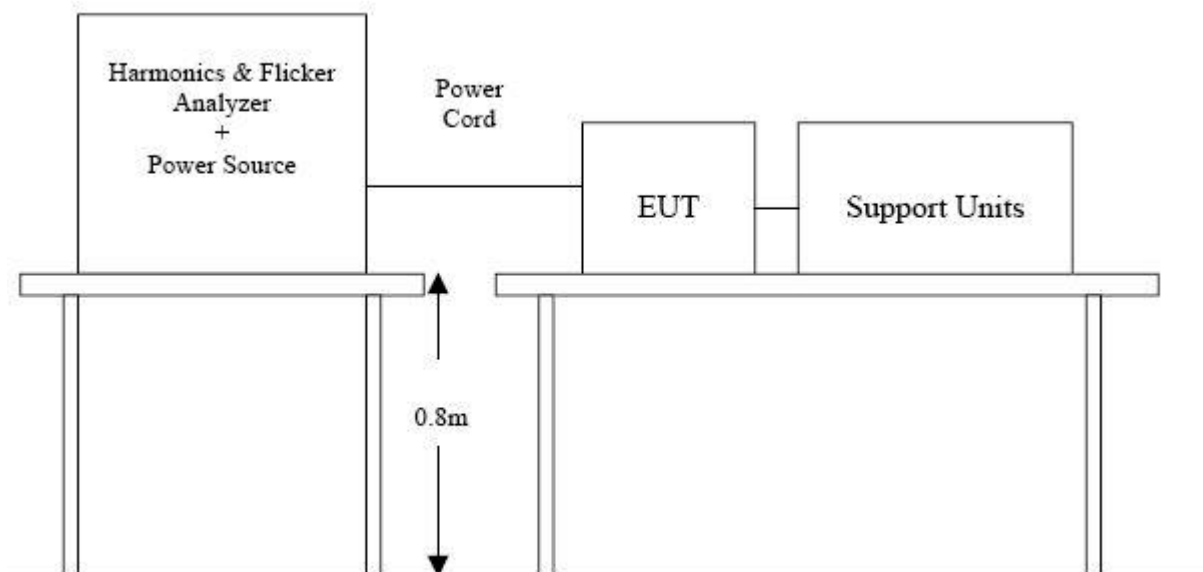

### 5.3 Test Procedure:

1. The EUT was placed on the top of a wooden table 0.8 meters above the ground and operated to produce the maximum harmonic components under normal operating conditions for each successive harmonic component in turn.
2. The correspondent test program of test instrument to measure the current harmonics emanated from EUT is chosen. The measure time shall be not less than the time necessary for the EUT to be exercised.



## 5.4 Test Result

|                       |   |
|-----------------------|---|
| Basic Standard:       | EN IEC 61000-3-2:2019+A1:2021   |
| Observation time      | 150s  |
| Windows width:        | 10 periods - (EN 61000-4-7 Edition 2000)  |
| Temperature:          | 24 ( °C )   |
| Humidity:             | 55 ( %RH )  |
| Atmospheric pressure: | 101.1 (kPa)   |
| Operating Mode:       | Mode1   |
| Test Result:          | Pass  |
| Note:                 | The EUT is DC supply, so this test item is not applicable, then this EUT could be deemed to comply with the requirements of EN IEC 61000-3-2:2019+A1:2021 without test. |

## 6 – VOLTAGE FLUCTUATIONS AND FLICKER TEST

### 6.1 Application and Limit of Voltage Fluctuations and Flicker Test

Compliance to these standards ensures that tested equipment will not generate flickers and voltage change at levels that cause unacceptable degradation of the main environment. This directly contributes to meeting compatibility levels established in other EMC standards, which defines compatibility levels for low-frequency conducted disturbances in low-voltage supply systems.

| Test Item | Limit | Remark  |
|-----------|-------|---|
| Pst       | 1.0   | Pst means short-term flicker indicator.       |
| Plt       | 0.65  | Plt means long-term flicker indicator.        |
| Tdt (ms)  | 500   | Tdt means maximum time that dt exceeds 3 %.   |
| dmax (%)  | 4%    | dmax means maximum relative voltage change.   |
| dc (%)    | 3.3%  | dc means relative steady-state voltage change |

### 6.2 Block Diagram of Test Setup:

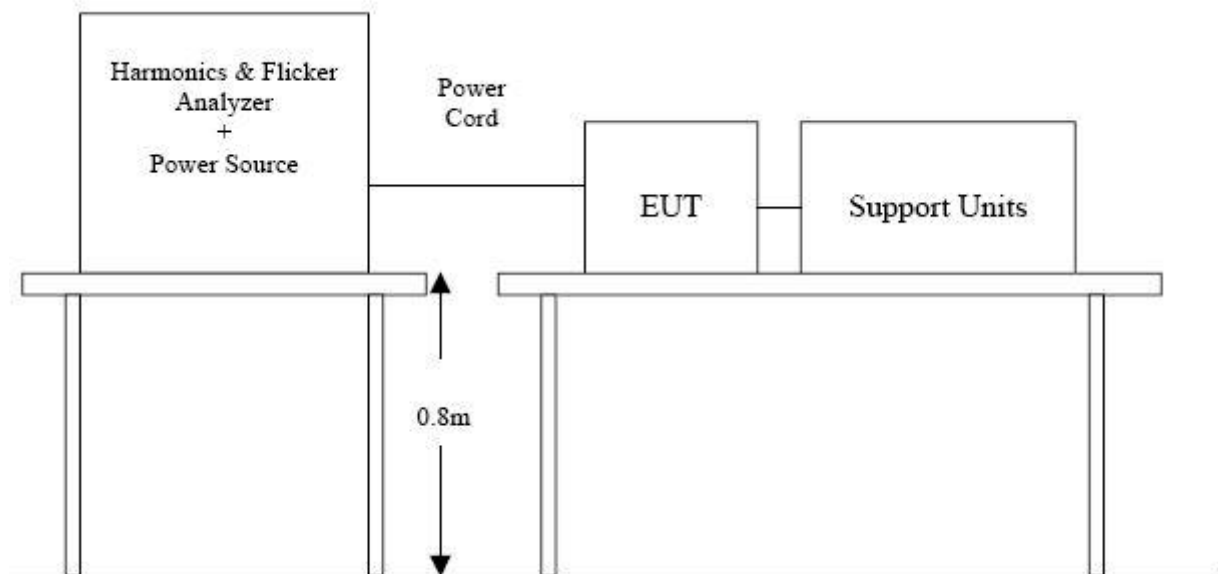

### 6.3 Test Procedure:

1. The EUT was placed on the top of a wooden table 0.8 meters above the ground and operated to produce the most unfavorable sequence of voltage changes under normal operating conditions.
2. During the flick measurement, the measure time shall include that part of whole operation cycle in which the EUT produce the most unfavorable sequence of voltage changes. The observation period for short-term flicker indicator is 10 minutes and the observation period for long-term flicker indicator is 2 hours.

## 6.4 Test Result

|                       |                                |
|-----------------------|--------------------------------|
| Basic Standard:       | EN 61000-3-3:2013+A2:2021      |
| Short time (Pst)      | 10 min                         |
| Observation time      | 10 min (1 Flicker measurement) |
| Temperature:          | 24 ( °C )                      |
| Humidity:             | 55 ( %RH )                     |
| Atmospheric pressure: | 101.1 (kPa )                   |
| Operating Mode:       | Mode1                          |
| Test Result:          | Pass                           |

| Maximum Flicker results |            |       |        |
|-------------------------|------------|-------|--------|
| Test Item               | EUT values | Limit | Result |
| Pst                     | /          | 1.000 | Pass   |
| dc [%]                  | /          | 3.300 | Pass   |
| dmax [%]                | /          | 4.000 | Pass   |
| dt [ms]                 | /          | 500   | Pass   |

## 7- IMMUNITY TEST DESCRIPTION

### 7.1 General Description

| Product Standard  | EN 61000-6-1  |   |
|---|---------------|---|
| Basic Standard, Specification, and Performance Criterion required | EN 61000-4-2  | Electrostatic Discharge – ESD: ±8kV air discharge, ±4kV Contact discharge, Performance Criterion B  |
|   | EN 61000-4-3  | Radio-Frequency Electromagnetic Field Susceptibility Test – RS: 80 ~ 1000 MHz, 3V/m, 80% AM (1kHz), Performance Criterion A   |
|   | EN 61000-4-4  | Electrical Fast Transient/Burst - EFT, Power line: ±1kV, Signal line: ±0.5kV, Performance Criterion B   |
|   | EN 61000-4-5  | Surge Immunity Test: 1.2/50 us Open Circuit Voltage, 8 /20 us Short Circuit Current, Power Line: line to line 1 kV, line to ground 2 kV Signal line: line to ground: outdoor: 1kV indoor: 0.5kV Performance Criterion B   |
|   | EN 61000-4-6  | Conducted Radio Frequency Disturbances Test – CS: 0.15 ~ 80 MHz, 3Vrms, 80% AM, 1kHz, Performance Criterion A   |
|   | EN 61000-4-11 | Voltage Dips:<br>1) 0% residual for 0.5 cycle, Performance Criterion B<br>2) 0% residual for 1 cycle, Performance Criterion B<br>3) 70% residual for 25/30 cycles for 50/60Hz, Performance Criterion C<br>Voltage Interruptions:<br>0% residual for 250/300 cycles for 50/60Hz, Performance Criterion C is required for EUT with battery back-up<br>Performance Criterion C is required for EUT without battery back-up |

**7.2 The phenomena allowed during and after test in each criterion are clearly stated in the following table**

| Performance criteria |  |   |
|----------------------|--|---|
| Criteria             | During test  | After test  |
| A                    | Shall operate as intended. May show degradation of performance (see note1). Shall be no loss of function. Shall be no unintentional transmissions. | Shall operate as intended. Shall be no degradation of performance (see note 2). Shall be no loss of function. Shall be no loss of stored data or user programmable functions.                         |
| B                    | May show loss of function (one or more). May show degradation of performance (see note 1). No unintentional transmissions.                         | Functions shall be self-recoverable. Shall operate as intended after recovering. Shall be no degradation of performance (see note 2). Shall be no loss of stored data or user programmable functions. |
| C                    | May be loss of function (one or more).   | Functions shall be recoverable by the operator. Shall operate as intended after recovering. Shall be no degradation of performance (see note 2).  |

NOTE 1:  
 Degradation of performance during the test is understood as a degradation to a level not below a minimum performance level specified by the manufacturer for the use of the apparatus as intended. In some cases the specified minimum performance level may be replaced by a permissible degradation of performance. If the minimum performance level or the permissible performance degradation is not specified by the manufacturer then either of these may be derived from the product description and documentation (including leaflets and advertising) and what the user may reasonably expect from the apparatus if used as intended.

NOTE 2:  
 No degradation of performance after the test is understood as no degradation below a minimum performance level specified by the manufacturer for the use of the apparatus as intended. In some cases the specified minimum performance level may be replaced by a permissible degradation of performance. After the test no change of actual operating data or user retrievable data is allowed. If the minimum performance level or the permissible performance degradation is not specified by the manufacturer then either of these may be derived from the product description and documentation (including leaflets and advertising) and what the user may reasonably expect from the apparatus if used as intended.

**7.3 Deviations from the standard**

No deviations from EN 61000-6-1 were made when performing the tests described in this report.

## 8- IMMUNITY TEST RESULTS

### 8.1 Electrostatic Discharge Immunity Test

#### 8.1.1 Test Specification

|                       |  |
|-----------------------|--|
| Basic Standard:       | EN 61000-4-2:2009  |
| Test Level:           | $\pm 8$ kV (Air Discharge)<br>$\pm 4$ kV (Contact Discharge)<br>$\pm 4$ kV (Indirect Contact HCP)<br>$\pm 4$ kV (Indirect Contact VCP) |
| Temperature:          | 23.6 ( °C )  |
| Humidity:             | 55 ( %RH )   |
| Atmospheric pressure: | 101.1 (kPa )   |
| Operating Mode:       | Mode1  |
| Operator:             | Dong ShengXi   |

#### 8.1.2 Test Setup

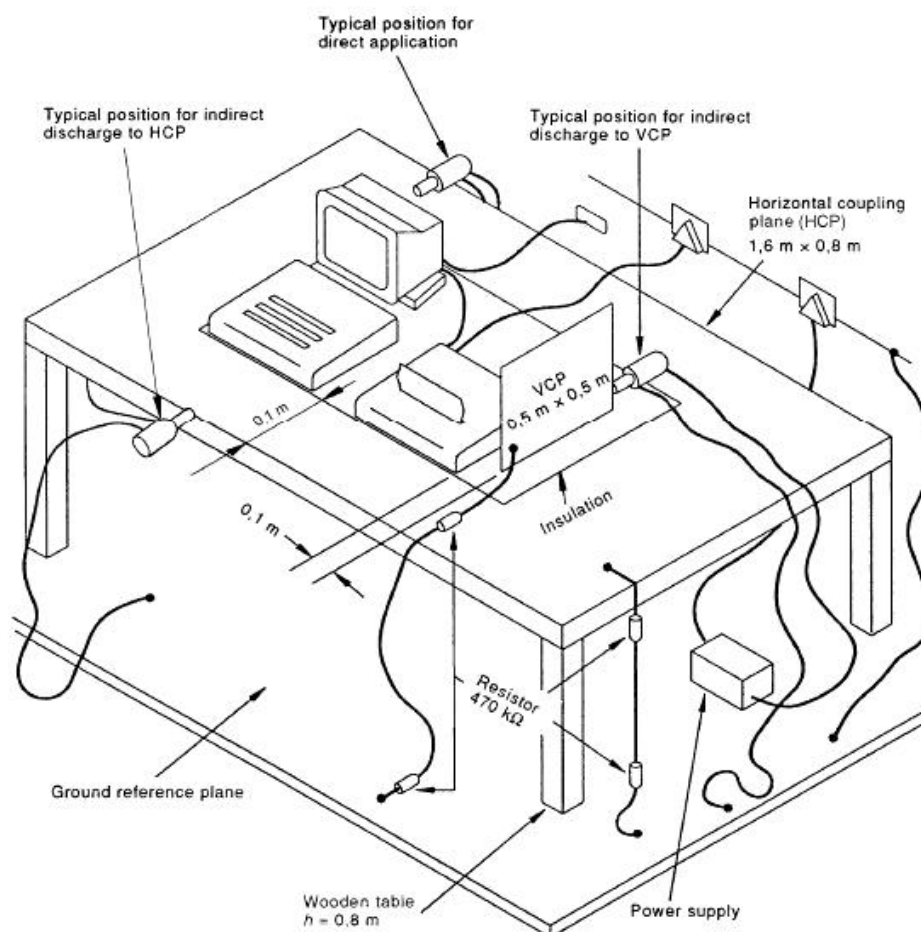

### 8.1.3 Test Procedure

1. Electrostatic discharges were applied only to those points and surfaces of the EUT that are accessible to users during normal operation.
2. The test was performed with at least ten single discharges on the pre-selected points in the most sensitive polarity.
3. The time interval between two successive single discharges was at least 1 second.
4. The ESD generator was held perpendicularly to the surface to which the discharge was applied and the return cable was at least 0.2 meters from the EUT.
5. Contact discharges were applied to the non-insulating coating, with the pointed tip of the generator penetrating the coating and contacting the conducting substrate.
6. Air discharges were applied with the round discharge tip of the discharge electrode approaching the EUT as fast as possible (without causing mechanical damage) to touch the EUT. After each discharge, the ESD generator was removed from the EUT and re-triggered for a new single discharge. The test was repeated until all discharges were complete.
7. At least ten single discharges (in the most sensitive polarity) were applied to the Horizontal Coupling Plane at points on each side of the EUT. The ESD generator was positioned horizontally at a distance of 0.1 meters from the EUT with the discharge electrode touching the HCP.
8. At least ten single discharges (in the most sensitive polarity) were applied to the center of one vertical edge of the Vertical Coupling Plane in sufficiently different positions that the four faces of the EUT were completely illuminated. The VCP (dimensions 0.5m x 0.5m) was placed vertically to and 0.1 meters from the EUT.

### 8.1.4 Performance Criterion Required & Test Result

Table 1: Electrostatic Discharge Immunity (Air Discharge)

| Test Level               |                          |                                     | Test Points | Observation Performance | Criterion Required |
|--------------------------|--------------------------|-------------------------------------|-------------|-------------------------|--------------------|
| ±2 kV                    | ±4kV                     | ±8kV                                |             |                         |                    |
| <input type="checkbox"/> | <input type="checkbox"/> | <input checked="" type="checkbox"/> | Gap         | B                       | B                  |
| <input type="checkbox"/> | <input type="checkbox"/> | <input checked="" type="checkbox"/> | Port        | B                       | B                  |
| <input type="checkbox"/> | <input type="checkbox"/> | <input checked="" type="checkbox"/> | Led         | B                       | B                  |
| <input type="checkbox"/> | <input type="checkbox"/> | <input checked="" type="checkbox"/> | Other Port  | B                       | B                  |

Table 2: Electrostatic Discharge Immunity (Direct Contact)

| Test Level               |                                     |                          | Test Points | Observation Performance | Criterion Required |
|--------------------------|-------------------------------------|--------------------------|-------------|-------------------------|--------------------|
| ±2 kV                    | ±4kV                                | ±8kV                     |             |                         |                    |
| <input type="checkbox"/> | <input checked="" type="checkbox"/> | <input type="checkbox"/> | Metal shell | B                       | B                  |
| <input type="checkbox"/> | <input checked="" type="checkbox"/> | <input type="checkbox"/> | Screw       | B                       | B                  |
| <input type="checkbox"/> | <input checked="" type="checkbox"/> | <input type="checkbox"/> | Key         | B                       | B                  |

Table 3: Electrostatic Discharge Immunity (Indirect Contact HCP)

| Test Level               |                                     |                          | Test Points | Observation Performance | Criterion Required |
|--------------------------|-------------------------------------|--------------------------|-------------|-------------------------|--------------------|
| ±2 kV                    | ±4kV                                | ±8kV                     |             |                         |                    |
| <input type="checkbox"/> | <input checked="" type="checkbox"/> | <input type="checkbox"/> | Front Side  | A                       | B                  |
| <input type="checkbox"/> | <input checked="" type="checkbox"/> | <input type="checkbox"/> | Back Side   | A                       | B                  |
| <input type="checkbox"/> | <input checked="" type="checkbox"/> | <input type="checkbox"/> | Left Side   | A                       | B                  |
| <input type="checkbox"/> | <input checked="" type="checkbox"/> | <input type="checkbox"/> | Right Side  | A                       | B                  |

Table 4: Electrostatic Discharge Immunity (Indirect Contact VCP)

| Test Level               |                                     |                          | Test Points | Observation Performance | Criterion Required |
|--------------------------|-------------------------------------|--------------------------|-------------|-------------------------|--------------------|
| ±2 kV                    | ±4kV                                | ±8kV                     |             |                         |                    |
| <input type="checkbox"/> | <input checked="" type="checkbox"/> | <input type="checkbox"/> | Front Side  | A                       | B                  |
| <input type="checkbox"/> | <input checked="" type="checkbox"/> | <input type="checkbox"/> | Back Side   | A                       | B                  |
| <input type="checkbox"/> | <input checked="" type="checkbox"/> | <input type="checkbox"/> | Left Side   | A                       | B                  |
| <input type="checkbox"/> | <input checked="" type="checkbox"/> | <input type="checkbox"/> | Right Side  | A                       | B                  |

Test Result: Pass



## 8.2 Radiated Susceptibility Test

### 8.2.1 Test Specification

|                       |                              |
|-----------------------|------------------------------|
| Basic Standard:       | EN IEC 61000-4-3:2020        |
| Frequency Range:      | 80~1000MHz                   |
| Modulation:           | Amplitude 80%, 1kHz sinewave |
| Test Level:           | 3V/m                         |
| Temperature:          | 23.6 ( °C )                  |
| Humidity:             | 55 ( %RH )                   |
| Atmospheric pressure: | 101.1 (kPa )                 |
| Operating Mode:       | Mode1                        |
| Operator:             | Harris Pan                   |

### 8.2.2 Test Setup

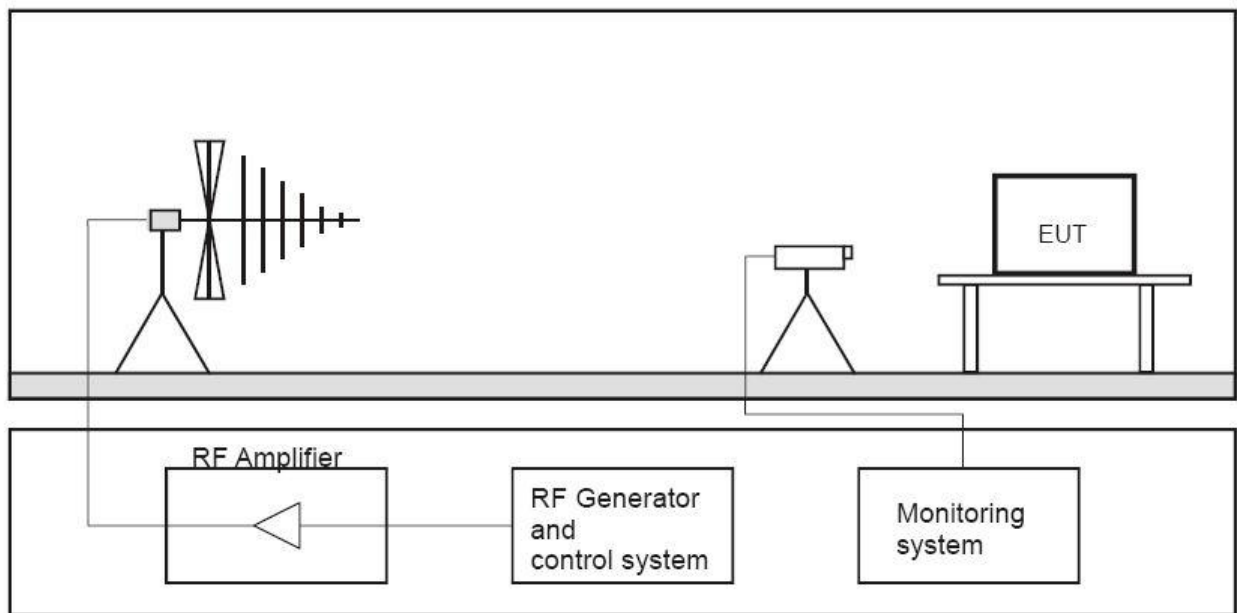

### 8.2.3 Test Procedure

1. The testing was performed in a fully-anechoic chamber.
2. The frequency range is swept from 80 MHz to 1000 MHz, with the signal 80% amplitude modulated with a 1kHz sine wave.
3. The dwell time at each frequency shall not be less than the time necessary for the EUT to be exercised and to respond, but shall in no case be less than 0,5s.
4. The field strength level was 3V/m.
5. The test was performed with the EUT exposed to both vertically and horizontally polarized fields on each of the four sides.

### 8.2.4 Performance Criterion Required & Test Result

| Frequency Band (MHz) | Test Level | Test Points | Observation Performance | Criterion Required |
|----------------------|------------|-------------|-------------------------|--------------------|
| 80-1000              | 3V/m       | Front Side  | A                       | A                  |
| 80-1000              | 3V/m       | Rear Side   | A                       | A                  |
| 80-1000              | 3V/m       | Left Side   | A                       | A                  |
| 80-1000              | 3V/m       | Right Side  | A                       | A                  |

Test Result: Pass

## 8.3 Electrical Fast Transient/Burst Immunity Test

### 8.3.1 Test Specification

|                       |   |
|-----------------------|---|
| Basic Standard :      | EN 61000-4-4:2012   |
| Test Level:           | ±1 kV for AC Power Line<br>±0.5 kV for Communication Line (If applicable) |
| Impulse Frequency:    | 5kHz  |
| Impulse Wave-shape:   | 5/50ns  |
| Burst Duration:       | 15ms  |
| Burst Period:         | 300ms   |
| Test Duration:        | 1 min.  |
| Temperature:          | 24 ( °C )   |
| Humidity:             | 55 ( %RH )  |
| Atmospheric pressure: | 101.1 (kPa )  |
| Operating Mode:       | Mode1   |

### 8.3.2 Test Setup

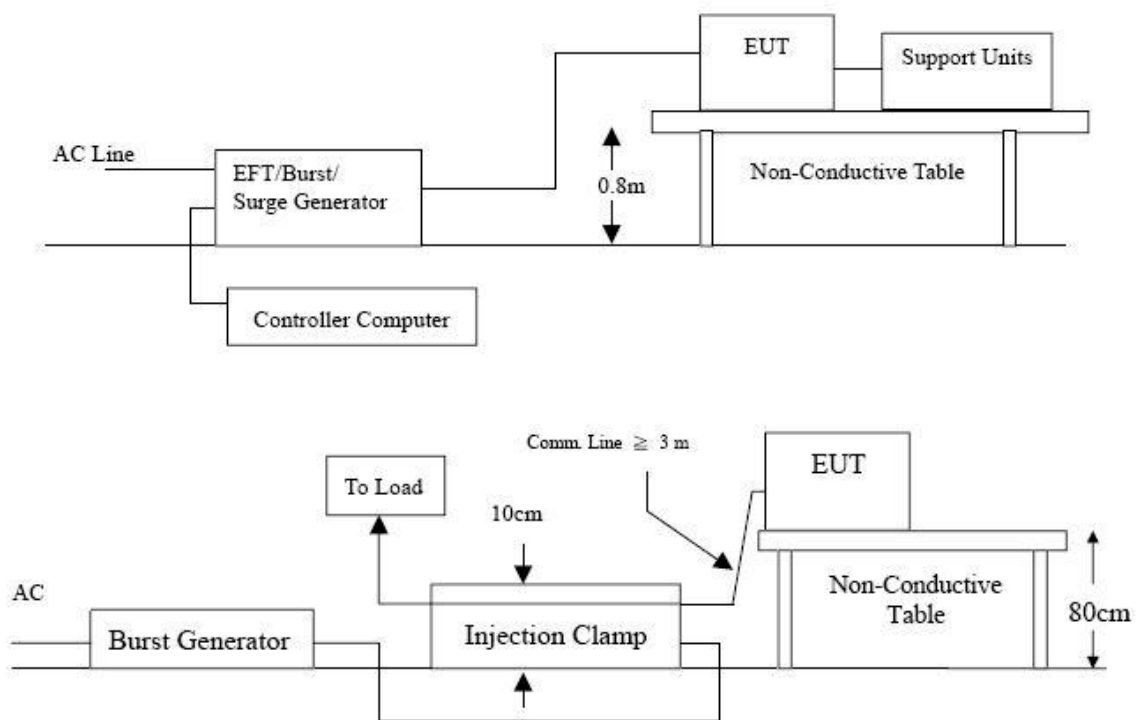

### 8.3.3 Test Procedure

1. Both positive and negative polarity discharges were applied.
2. The length of the “hot wire” from the coaxial output of the EFT generator to the terminals on the EUT should be 0.5m.
3. The duration time of each test sequential was 1 minute.
4. The transient/burst waveform was in accordance with EN 61000-4-4, 5/50ns.

### 8.3.4 Performance Criterion Required & Test Result

| Voltage | Test Points | Observation Performance | Criterion Required |
|---------|-------------|-------------------------|--------------------|
| ±1kV    | /           | A                       | B                  |
| ±1kV    | /           | A                       | B                  |
| ±1kV    | /           | A                       | B                  |
| ±1kV    | /           | /                       | /                  |
| ±1kV    | /           | A                       | B                  |
| ±1kV    | /           | A                       | B                  |
| ±1kV    | /           | A                       | B                  |
| ±0.5kV  | /           | /                       | /                  |
| ±0.5kV  | /           | /                       | /                  |
| ±0.5kV  | /           | /                       | /                  |

Test Result: Pass

Passed                       Not Applicable

Note: The EUT is DC supply, so this test item is not applicable.

## 8.4 Surge Immunity Test

### 8.4.1 Test Specification

|                        |   |
|------------------------|---|
| Basic Standard :       | EN 61000-4-5:2014+A1:2017   |
| Test Level:            | ±0.5, 1 kV (Line to Line) for AC Power Line<br>±0.5, 1, 2 kV (Line(s) to Ground) for AC Power Line<br>±0.5 kV for unshielded unsymmetrically operated interconnection lines (If applicable) |
| Wave-Shape:            | Combination Wave<br>1.2/50 us Open Circuit Voltage<br>8/20 us Short Circuit Current   |
| Generator Impedance:   | 42 ohm between signal line and ground<br>2 ohm between networks   |
| Phase Angle:           | 0° /90°/180°/270°   |
| Pulse Repetition Rate: | 1 time / min  |
| Number of Tests:       | 5 positive and 5 negative at selected points  |
| Temperature:           | 24 ( °C )   |
| Humidity:              | 55 ( %RH )  |
| Atmospheric pressure:  | 101.1 (kPa )  |
| Operating Mode:        | Mode1   |

### 8.4.2 Test Setup

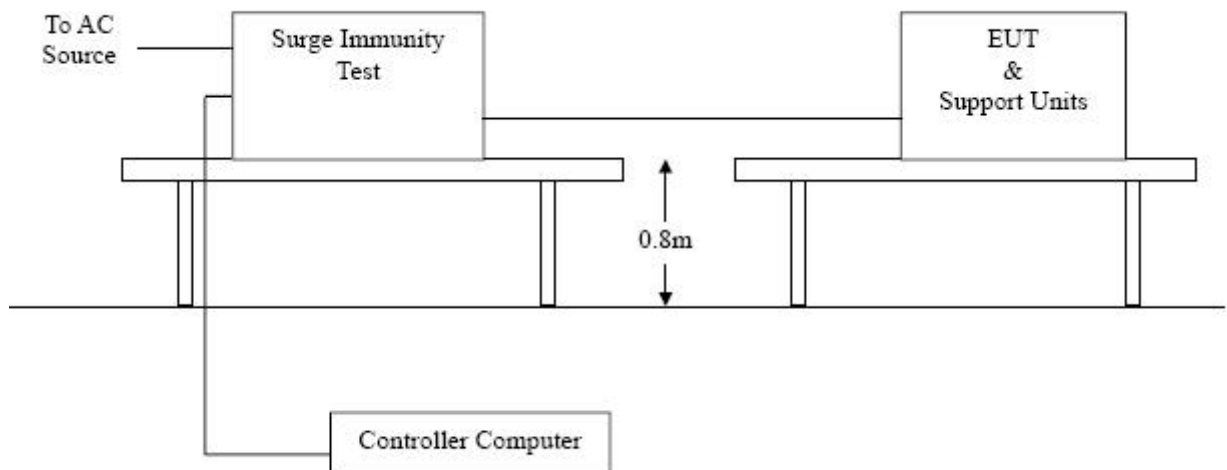

### 8.4.3 Test Procedure

1. For EUT LiFePO4 Battery(Li-ion) :

The surge is applied to the EUT LiFePO4 Battery(Li-ion) terminals via the capacitive coupling network. Decoupling networks are required in order to avoid possible adverse effects on equipment not under test that may be powered by the same lines, and to provide sufficient decoupling impedance to the surge wave. The power cord between the EUT and the coupling/decoupling networks was shorter than 2 meters in length.

2. For test applied to unshielded unsymmetrically operated interconnection lines of EUT: (If applicable)

The surge was applied to the lines via the capacitive coupling. The coupling / decoupling networks didn't influence the specified functional conditions of the EUT. The interconnection line between the EUT and the coupling/decoupling networks was shorter than 2 meters in length.

### 8.4.4 Performance Criterion Required & Test Result

| Voltage | Test Points | Observation Performance | Criterion Required |
|---------|-------------|-------------------------|--------------------|
| ±0.5kV  | /           | /                       | /                  |
| ±1kV    | /           | A                       | B                  |
| ±2kV    | /           | A                       | B                  |
| ±4kV    | /           | A                       | B                  |
| ±0.5kV  | /           | /                       | /                  |
| ±0.5kV  | /           | /                       | /                  |
| ±0.5kV  | /           | /                       | /                  |

Test Result: Pass

- Passed                       Not Applicable

Note: The EUT is DC supply, so this test item is not applicable.

## 8.5 Conducted Susceptibility Test

### 8.5.1 Test Specification

|                       |                                  |
|-----------------------|----------------------------------|
| Basic Standard:       | EN 61000-4-6:2014+AC:2015        |
| Test Level:           | 3Vr.m.s                          |
| Frequency Range:      | 0.15~80MHz                       |
| Modulation:           | Amplitude 80%, 1kHz sinewave     |
| Frequency Step:       | 1 % of preceding frequency value |
| Temperature:          | 24 ( °C )                        |
| Humidity:             | 55 ( %RH )                       |
| Atmospheric pressure: | 101.1 ( kPa )                    |
| Operating Mode:       | Mode1                            |
| Operator:             | Dong ShengXi                     |

### 8.5.2 Test Setup

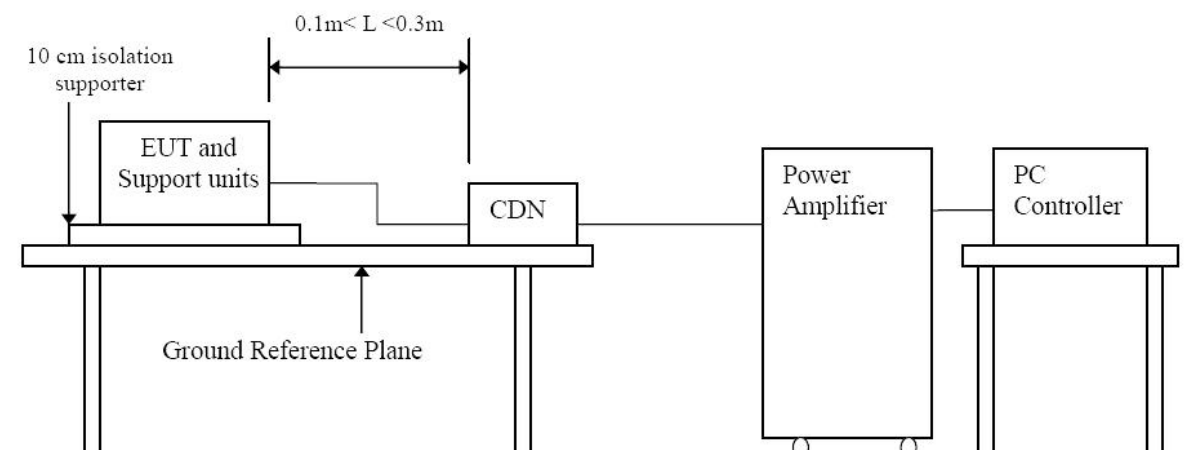

### 8.5.3 Test Procedure

1. The test was performed with the test generator connected to each of the coupling and decoupling devices in turn, while the other non-excited RF input ports of the coupling devices are terminated by a 50-ohm load resistor.
2. The frequency range was swept from 150 kHz to 80 MHz, using the signal level established during the setting process and with a disturbance signal of 80 % amplitude. The signal was modulated with a 1 kHz sine wave, pausing to adjust the RF signal level or the switch coupling devices as necessary. The sweep rate was  $1.5 \times 10^{-3}$  decades/s. Where the frequency range is swept incrementally, the step size was 1 % of preceding frequency value from 150 kHz to 80 MHz.

3. The dwell time at each frequency was less than the time necessary for the EUT to be exercised, and able to respond. Sensitive frequencies such as clock frequency(ies) and harmonics or frequencies of dominant interest, was analyzed separately.
4. Attempts was made to fully exercise the EUT during testing, and to fully interrogate all exercise modes selected for susceptibility.

#### 8.5.4 Performance Criterion Required & Test Result

| Frequency Band (MHz) | Voltage (Vrms) | Test Points | Observation Performance | Criterion Required |
|----------------------|----------------|-------------|-------------------------|--------------------|
| 0.15-80              | 3              | /           | A                       | A                  |

Test Result: Pass

Passed  Not Applicable

Note: The EUT is DC supply, so this test item is not applicable.



## 8.6 Voltage Dips, Short Interruptions Immunity Tests

### 8.6.1 Test Specification

|                         |  |
|-------------------------|--|
| Basic Standard:         | EN IEC 61000-4-11:2020/AC:2022   |
| Test Level:             | Voltage Dips:<br>1) 0% residual voltage for 0.5 cycle,<br>2) 0% residual voltage for 1 cycle,<br>3) 70% residual voltage for 25/30 cycles,<br>Voltage Interruptions:<br>0% residual voltage for 250/300 cycles |
| Interval between event: | 10 seconds   |
| Phase Angle:            | 0°/180°  |
| Test cycle:             | 3 times  |
| Temperature:            | 24 ( °C )  |
| Humidity:               | 55 ( %RH )   |
| Atmospheric pressure:   | 101 ( kPa )  |
| Operating Mode:         | Mode1  |

### 8.6.2 Test Setup

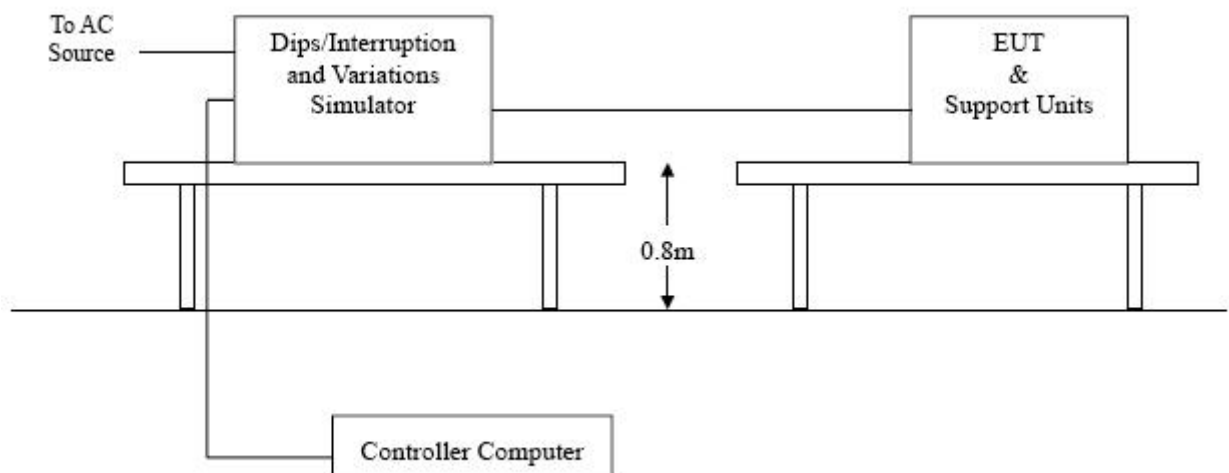

### 8.6.3 Test Procedure

The EUT was tested for each selected combination of test levels and duration with a sequence of 3 dips/interruptions with intervals of 10s (between each test event). Each representative mode of operation shall be tested. Abrupt changes in supply voltage shall occur at zero crossings of the voltage waveform.

### 8.6.4 Performance Criterion Required & Test Result

| Ut: 230V AC, 50Hz    |                   |                         |                    |
|----------------------|-------------------|-------------------------|--------------------|
| Voltage (% Residual) | Duration (Period) | Observation Performance | Criterion Required |
| 0                    | 0.5               | /                       | B                  |
| 0                    | 1                 | /                       | B                  |
| 70                   | 25                | /                       | C                  |
| 0                    | 250               | /                       | C                  |

| Ut: 230V AC, 60Hz    |                   |                         |                    |
|----------------------|-------------------|-------------------------|--------------------|
| Voltage (% Residual) | Duration (Period) | Observation Performance | Criterion Required |
| 0                    | 0.5               | /                       | B                  |
| 0                    | 1                 | /                       | B                  |
| 70                   | 30                | /                       | C                  |
| 0                    | 300               | /                       | C                  |

Test Result: Pass

Passed                       Not Applicable

Note: The EUT is DC supply, so this test item is not applicable.

**APPENDIX A - EUT PHOTOGRAPHS**

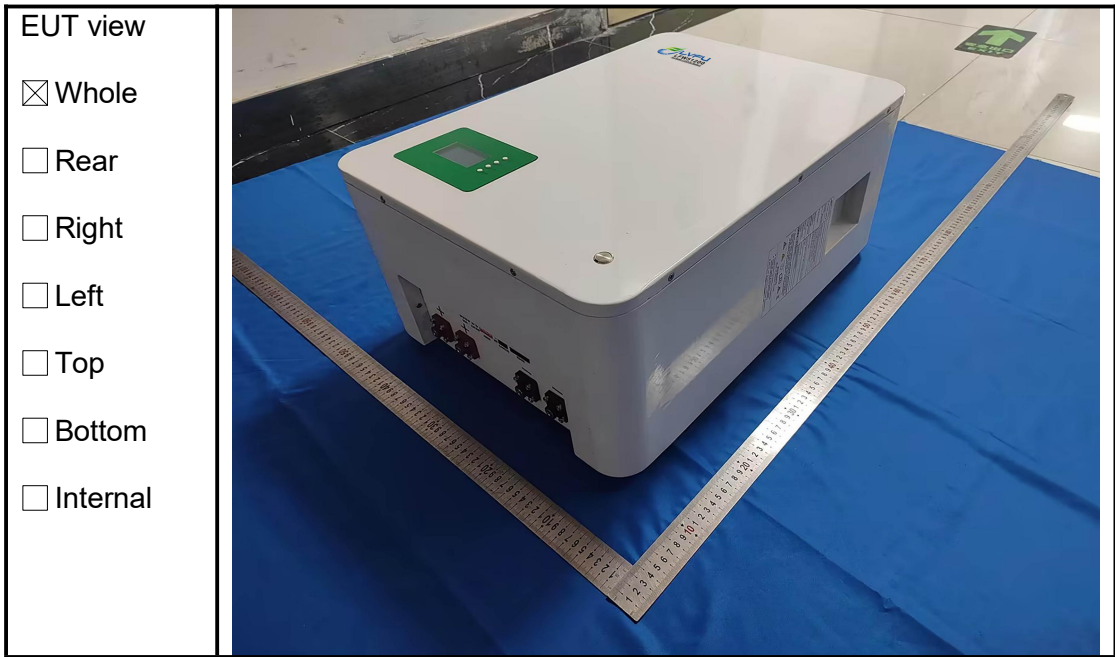

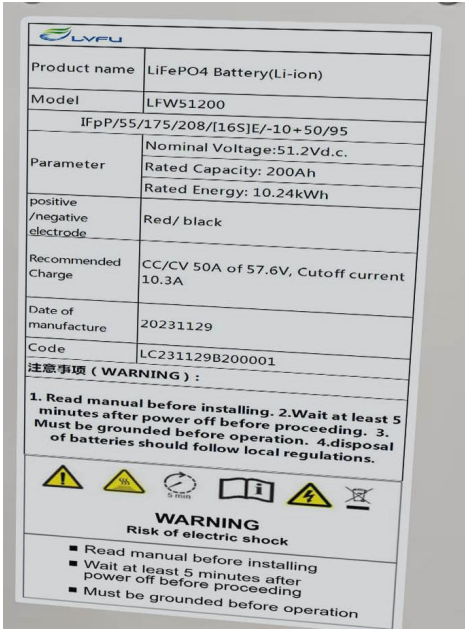
|  |  |
|--|--|
| <p>EUT view</p> <p><input checked="" type="checkbox"/> Whole</p> <p><input type="checkbox"/> Rear</p> <p><input type="checkbox"/> Right</p> <p><input type="checkbox"/> Left</p> <p><input type="checkbox"/> Top</p> <p><input type="checkbox"/> Bottom</p> <p><input type="checkbox"/> Internal</p> |  |
|--|--|

**Statement**

- 1.This report is considered invalid without approved signature and special;
- 2.The Applicant name and Address, the sample(s) and sample information was/were provided by the applicant who should be responsible for the authenticity which SiCT hasn’ t verified;
- 3.The result(s) shown in this report refer(s) only to the sample(s) tested;
- 4.Without written approval of SiCT, this report can’ t be reproduced except in full.

---END OF REPORT ---